

TECHNICAL DATA SHEET

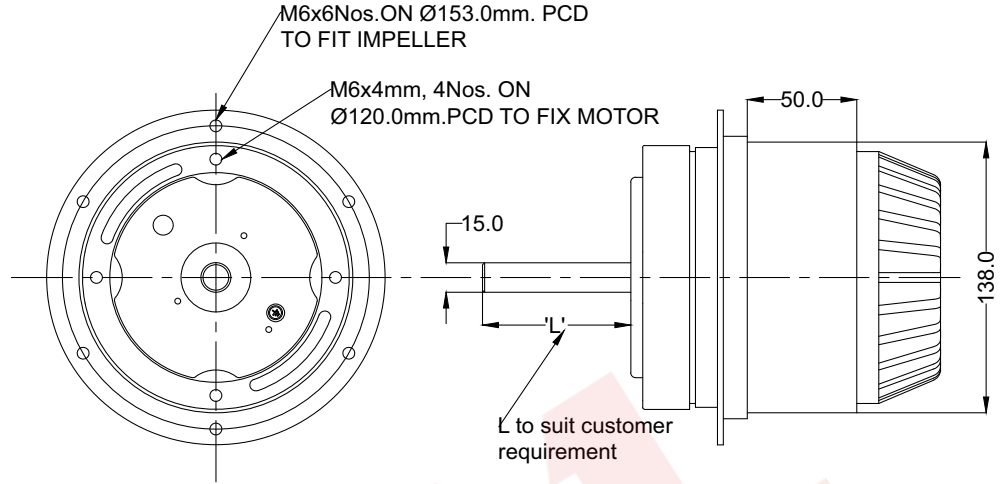

NOTE:- ALL DIMENSION ARE IN MM.

SPECIFICATIONS (50 Hz)

Volt (V)	Watts (No Load) (W)	Watts (Rated) (W)	Current (No Load) (A)	Current (Rated) (A)	Speed (RPM)	Capacitor (µF)	Noise (dBA)	Nt. Wt. (Kg)
230	150	305	0.60	1.30	900	10.0	50	8.0

MECHANICAL CHARACTERISTIC

Rotor	Aluminum Die Cast With Powder Coated
Type Of Protection	IP-54
Insulation Class	"F"
Bearing	Maintenance Free Ball Bearing
Motor Protected	Thermally Protected At 145°C
Permissible Ambient Temperature	0° To 60° C
High Voltage Test According to IS	3588-1987
Cable Length	1.5 Sq.mm-6 Core Wire,600mm.
Balacing Grade	Fans Conform 6.3 Grade As Recommended By IS 1940-1-2003
Direction Of Rotation	Counter Clockwise, Clockwise Seen On Rotor

WIRING DIAGRAM

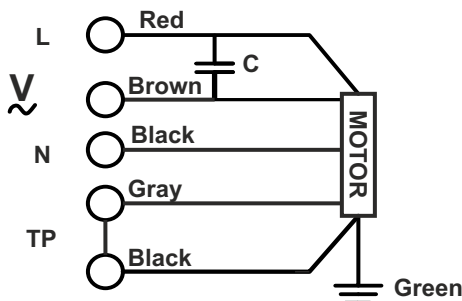

DRAWN BY	V.J.P	TITLE:- MODEL : MO138-6E-M7
CHECKED BY	J.G.P	
APPROVED BY	S.B.D	
SCALE N.T.S.	SHEET 1 OF 1	REV/DATE: 01,27.05.2021

Note:- All Information contained in this document is **CONFIDENTIAL** and the property of HETAL INDUSTRIES
Reproduction of this in any form is to be done with the specific permission of the company.